

FURUNO

OPERATOR'S MANUAL

COLOR VIDEO SOUNDER

MODEL FCV-561

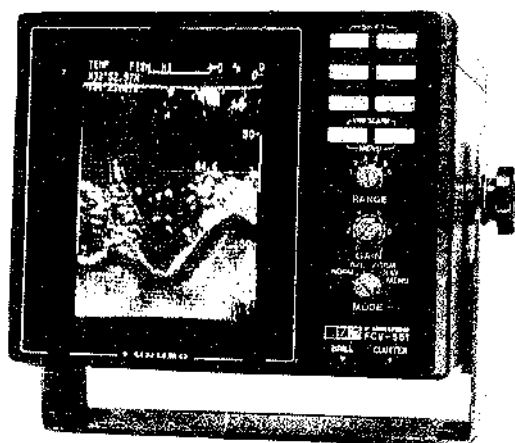

FURUNO ELECTRIC CO., LTD.
NISHINOMIYA, JAPAN

891140HO (8911, maus)
PRINTED IN JAPAN

WARNING AGAINST HIGH TENSION

The operation of this equipment involves the use of high voltage, which endangers human life. Although the design of the equipment has been made in due consideration of measures to insure the operator's safety, adequate precaution must be exercised when reaching inside the equipment for the purpose of maintenance and service. Do not change a component or inspect the equipment with the voltage applied. A residual charge may exist in some capacitors with the equipment turned off. Always short all supply lines to the chassis with an insulated screwdriver or a similar tool prior to touching the circuit.

FIRST AID IN CASE OF ELECTRIC SHOCK

When a victim struck by electricity is found, first switch off the equipment via the main switch on the equipment or the ship's distribution board. If this is not possible, protect yourself with dry insulating material (a wooden plate or rod, cloth, your belt, etc.) and pull the victim clear of electricity. If the victim is not breathing himself, apply artificial respiration according to the "Method of Artificial Respiration." Do not give up halfway. Perseverance and continual efforts are important in artificial respiration.

METHOD OF ARTIFICIAL RESPIRATION

Lay the victim on his back. Position yourself beside the victim's head and pinch his nose by your thumb and forefinger to prevent air leakage. Insert the thumb of your other hand between the victim's teeth and lift his chin up. Then, place the arm (the one closing the victim's nose) on the victim's forehead and press the head down so that the victim's head is given a maximum backward tilt with the chin prominent and the neck bent back. Seal the victim's mouth with your mouth and blow therein about half of the deeply inhaled air every time. After exhaling, turn your head to watch for a chest contraction, whilst inhaling deeply in readiness for the next blowing. Repeat the movements faster for the first 1 to 2 minutes and 12 times per minute thereafter.



Table of Contents

A WORD TO FURUNO FCV-561 OWNERS	1
FEATURES	1
1. HANDLING PRECAUTION	2
2. SYSTEM CONFIGURATION	3
3. OPERATION CONTROLS	4
4. BASIC OPERATION	5
Power On/off	5
Adjusting Brilliance.....	5
Selecting Presentation Mode.....	5
5. E/S (NORMAL, B/L, ZOOM) MODE OPERATION	6
Basic Range Selection.....	6
Shifting Range	6
Adjusting Gain	6
Picture Advance Speed Selection	6
Selecting Background Color	7
Eliminating Interference	7
Eliminating Low Level Noise.....	7
Measuring Depth to a Fish School	7
Eliminating Low Intensity Echoes.....	8
Automatic Bottom Tracking.....	8
Detecting Fish School or Seabed Aurally	8
6. NAVIGATION DATA (NAV) MODE OPERATION	9
Selecting Temperature Graph Range.....	9
Selecting Advance Speed of Water Temperature Graph	9
Activating Water Temperature Alarm	9
7. MENU SCREEN SETTING	10
Operating Procedure	10
DESCRIPTION OF MENU ITEM	11
Noise Limiter.....	11
Bottom-lock Range Selection.....	11
Shift Mode	11
TX Rate (PRR).....	12
Graph Plotting Speed.....	13
Bottom Alarm And Fish Alarm On/off	13
Alarm Zone	13
Temperature Limit	13
Temperature Alarm	14
Data Display	14
Scale Display.....	14

Range Set	15
8. INDICATORS	16
ECHO SOUNDER PICTURE	16
Normal Mode.....	16
Normal + Bottom-Lock (B/L) Expansion Mode.....	16
Normal + Zoom Mode.....	17
NAVIGATION DATA PICTURE	17
Navigation Data Mode	17
9. IF SOMETHING SHOULD GO WRONG WITH YOUR UNIT	19
OPERATION CHECK	19
SYSTEM DIAGNOSIS (SELF-CHECK)	20
10. INSTALLATION	21
DISPLAY UNIT.....	21
Mounting Procedure	22
TRANSDUCER.....	22
FCV-561 CABLING DIAGRAM	23
HOOKING UP SHIP'S POSITION DATA FROM POSITION FIXING EQUIPMENT.....	25
Furuno LC-90 Loran Receiver.....	25
Furuno FSN-50 Satellite Navigator.....	26
Other Position Fixing Equipment with NMEA 0183 Format	26
11. AFTER INSTALLATION CHECK.....	27
Operation Procedure	27
Description System Menu Item	27
Changing Data Format.....	28
12. SPECIFICATIONS	29
APPENDIX	AP-1
1. Starting FCV-561 with Factory Settings or User's Standard Settings.....	AP-1
2. List of Special Key Operation	AP-2
3. Combination of Background color and Echo Colors	AP-2
4. Changing Output Power to 300W or 1kW.....	AP-3
5. List of Factory Settings	AP-4
SCHEMATIC DIAGRAM.....	S-1

A WORD TO FURUNO FCV-561 OWNERS:

Congratulation on your choice of the FURUNO FCV-561 Color Video Sounder! For over 30 years Furuno Electric company has enjoyed an enviable reputation for quality and reliability throughout the world. This dedication to excellence is furthered by our extensive global network of agents and dealers.

The FCV-561 is designed and constructed to give the users many years of trouble-free operation. However to obtain optimum performance from this unit, you should carefully read and follow the recommended procedures for installation, operation and maintenance. No machine can perform to the at most of its ability unless it is installed and maintained properly.

Thank you for considering and purchasing Furuno equipment.

FEATURES

- 1) 8-color presentation (including background) shows detailed information on fish density and the nature of the bottom, on an 8" diagonal CRT. Selectable background color lessens eye-fatigue in both daytime and nighttime operations.
- 2) Easy-to-operate design permits to use the unit without consulting operator's manual; each key operation can be confirmed with double-size capital letters displayed for five seconds.
- 3) Variety of display modes; normal, bottom-lock expansion, zoom and navigation*, suit any types of fishing and help safe navigation.
 - * Optional position fixing equipment and temperature/speed sensor are required.
- 4) The alarm function enables to monitor echoes from fish schools and seabed aurally.
- 5) Powerful noise limiter ensures interference free operation on congested fishing ground.
- 6) Universal 11-40VDC power supply, drawing 45W of power.

1. HANDLING PRECAUTION

1. Moderate screen brightness to extend life of CRT.
2. Do not remove display cover. High voltage exists inside.
3. Do not use too high a setting of the **CLUTTER**. Color balance of the picture will be lost.

- Observe the following points will help to keep your FCV-561 in top condition for many years.

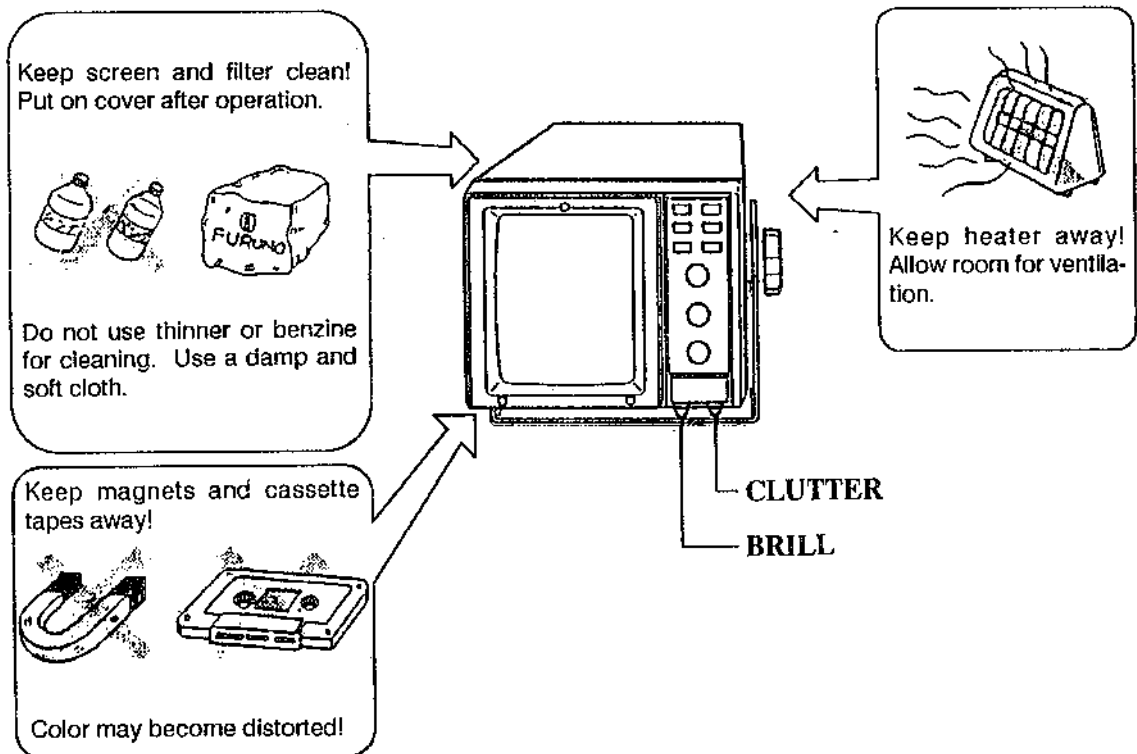

2. SYSTEM CONFIGURATION

The FCV-561 consists of the following units.

DISPLAY UNIT CV-561

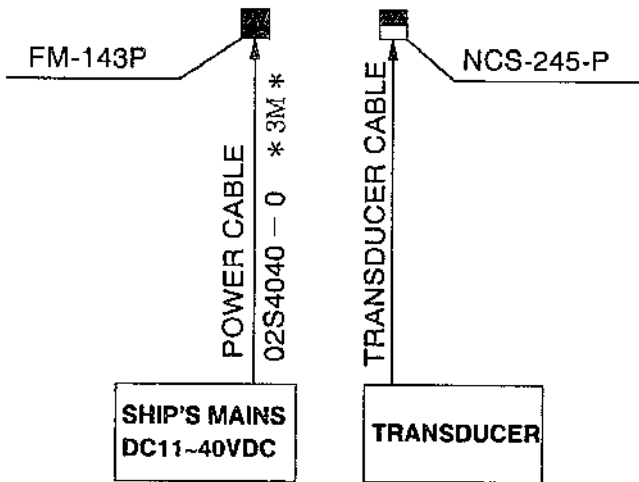
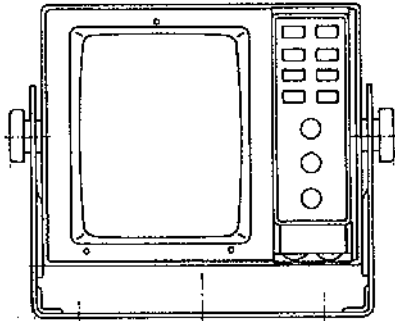

(STANDARD SUPPLY)

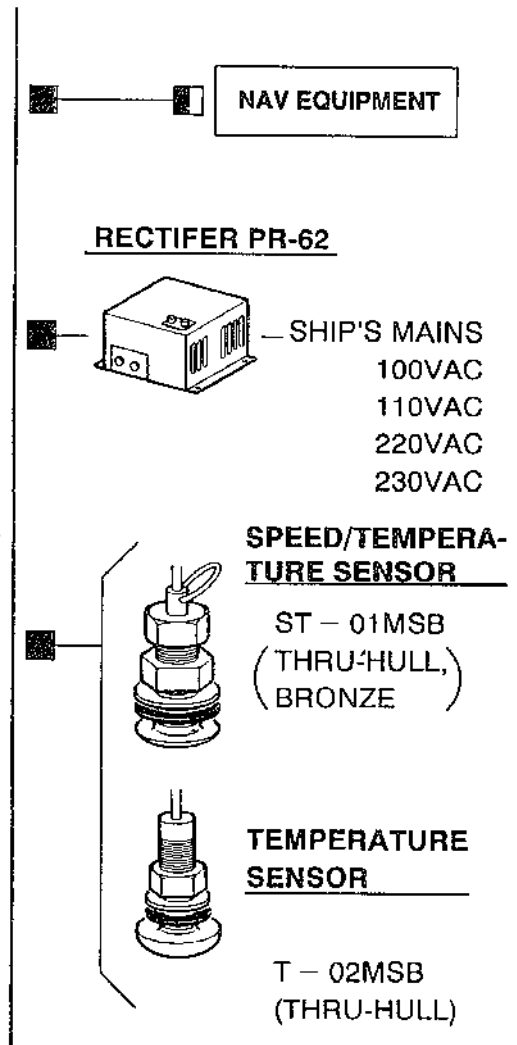

(OPTIONAL SUPPLY)

- Connector fitted at factory
- Connector to be fitted at installation

3. OPERATION CONTROLS

The front part of the display unit is separated into two sections: controls on the right-hand side and the CRT on the left-hand side.

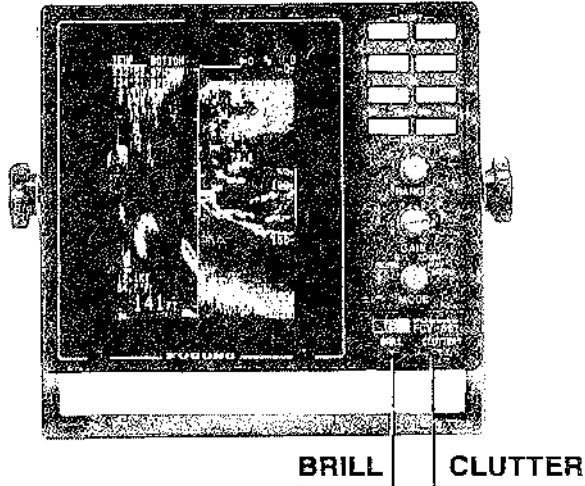

F Photo No.1892

KEY	FUNCTION
	Changes the start depth of the picture.
ADVANCE	Selects picture advance speed.
HUE	Determines background color of the picture.
SIG LEV	Eliminates low intensity echoes in four steps upto yellow color echoes.
ALARM	Turns on/off the alarm function.
	Moves the variable range marker(VRM). These are also used to set the alarm zone or to change the MENU settings.
SWITCH	FUNCTION
RANGE	Sets the basic range of the picture.
MODE	Turns on/off the unit and sets presentation mode.
GAIN	Adjusts picture sensitivity.
BRILL	Adjusts screen brilliance.
CLUTTER	Rejects noise which appears over the screen due to water contamination, etc.

4. BASIC OPERATION

The FCV-561 is simple to operate. Most of the major functions can be set with single key stroke and each key operation can be confirmed by double size capital letters displayed for five seconds.

Power On/off

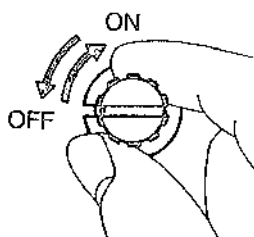

“ON” Turn the **MODE** switch clockwise until a click sound is heard.

“OFF” . . . Turn the **MODE** switch fully counterclockwise to “OFF” position.

Adjusting Brilliance

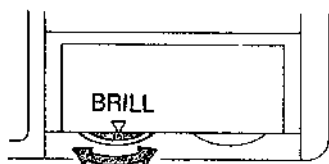

The picture brilliance is adjusted with the **BRILL** control. Keep the moderate brilliance to extend the life of the CRT.

Selecting Presentation Mode

Five presentation modes are available and you may select one of them with the **MODE** switch.

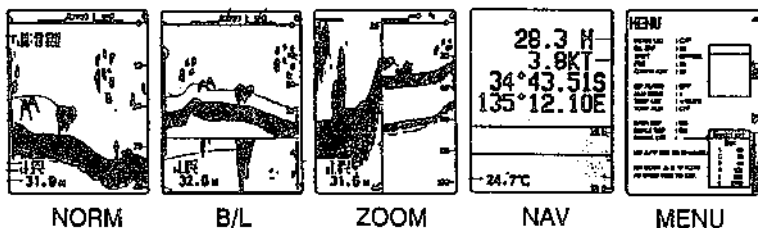
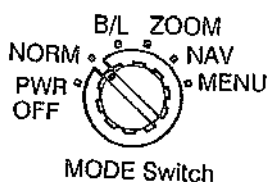

NOTE: 1. For the bottom-lock (B/L) expansion picture, the seabed contour must be steadily and distinctly plotted in red or reddish brown.

2. In the zoom picture, one scale division beneath the VRM is zoomed up in the left half of the screen. The zoom range bar is indicated on the barrier between the normal and zoom pictures. See page 17.

5. E/S (NORMAL, B/L, ZOOM) MODE OPERATION

Basic Range Selection

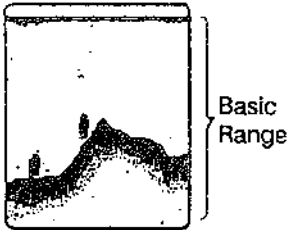

The basic range may be selected with the **RANGE** switch from six ranges listed below. The six ranges can be operator-reprogrammed as explained on page 15.

		1	2	3	4	5	6
Basic Range	M	10	20	40	80	150	300
	FT	30	60	120	250	500	1000
	FA	5	10	20	40	80	160
	P/B	6	12	25	50	100	200

B/L Range → Can be set on the menu screen.
See page 11.

Zoom Range → Fix; one scale division of the depth scale of the normal picture.

Shifting Range

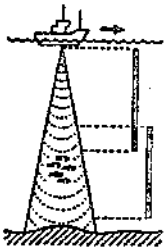

The range shift is to shift the start depth of the picture displayed on the screen with the **SHIFT** $\boxed{-}$ $\boxed{+}$ keys.

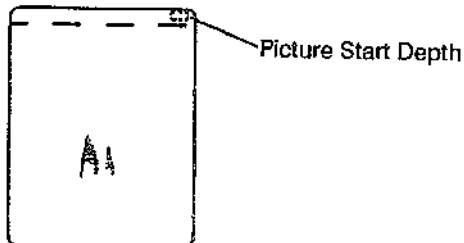

Adjusting Gain

The **GAIN** control adjusts the sensitivity of the receiver. Set it to the point just below where excessive noise appears on the screen.

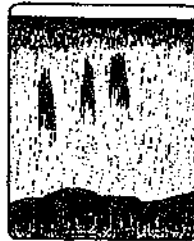

High



Proper



Low

Picture Advance Speed Selection

Press the **ADVANCE** key to set the picture advance speed. Every pressing changes the on-screen indication as well as the advance speed.

← ○	0	1	2	3	4
Speed	Stop	Slow	Medium	Fast	Fastest

Selecting Background Color

Press the **HUE** key to change the background color. Every pressing changes not only the background color (black, deep blue, blue, light blue) but also the echo colors as shown on page AP-2.

Eliminating Interference

When interference from other acoustic equipment operating nearby or other electric equipment can be seen on the screen, use the noise limiter function which can be set on the menu screen. See page 10.

Interference from nearby echo sounder



Interference from other electric devices

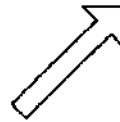
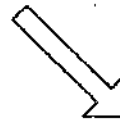
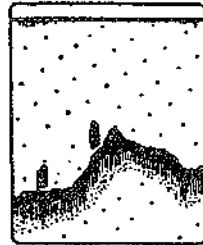

Eliminating Low Level Noise

When blue dots appear on the whole screen mainly due to contaminated water, use the **CLUTTER** control to eliminate them.

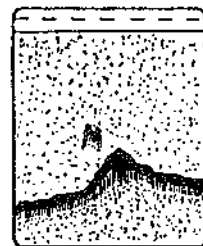

*NOTE: Do not turn the **CLUTTER** control excessively clockwise, otherwise weak echoes may be eliminated.*

Measuring Depth to a Fish School

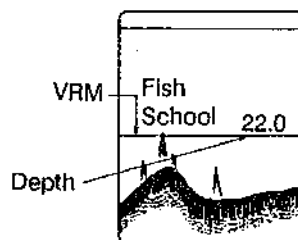

Move the VRM marker onto a fish school with the **▲** **▼** keys, and the depth to the fish school is digitally read out at the right-hand side of the marker.

Eliminating Low Intensity Echoes

When you wish to display fish schools above certain level, press the **SIG LEV** (Signal Level) key. Every pressing eliminates the weakest color echoes on the screen, upto yellow echoes with four key strokes. The echoes eliminated can be identified with the color bar whose color is eliminated in the same order.

On-Screen Indication	0	1	2	3	4
Eliminated Color	NO	BLU	L-BLU	GRN	YEL

Automatic Bottom Tracking

To keep the bottom echoes always on the screen, use the automatic bottom tracking function which can be activated on the menu screen. Refer to page 11.

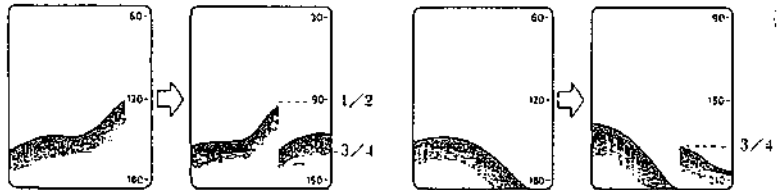

Detecting Fish School or Seabed Aurally

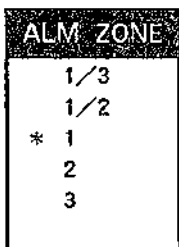
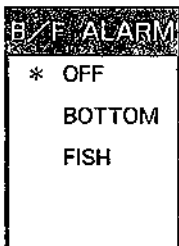

The alarm function enables you to aurally detect a fish school or seabed within a predetermined zone through the buzzer. Follow the procedure below to use the alarm function.

- 1) Set the **MODE** switch to MENU position. The menu screen will be displayed.
- 2) Select the **B/F ALARM** item with the \blacktriangle \blacktriangledown keys and then select **FISH** or **BOTTOM** alarm. See page 13.
- 3) Set the alarm zone width. See page 13.
- 4) Turn the **MODE** switch to other position restore the echo sounder picture.
- 5) Press the **ALARM** switch and then move the alarm zone marker to the desired depth with the \blacktriangle \blacktriangledown keys.
- 6) To turn off the alarm function, erase the "BOTTOM" or "FISH" indication on the top of the screen by pressing **ALARM** key.

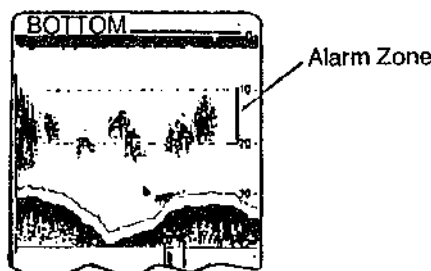

6. NAVIGATION DATA (NAV) MODE OPERATION

- This mode can be used only when the FCV-561 is connected with the optional temperature speed sensor and navigation equipment.

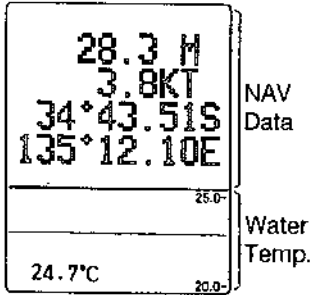

Set the **MODE** switch to “NAV” position.

The navigation data (depth, ship’s speed, ship’s position) are displayed on the upper 2/3 of the screen and the water temperature graph on the lower 1/3.

Selecting Temperature Graph Range

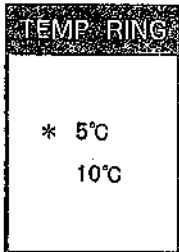

The temperature scale of the temperature graph is normally 5°C in range but can be changed to 10°C. See page 27.

Note that the temperature scale automatically changes in 5°C or 10°C steps when the temperature reaches the upper/lower limit of the displayed scale.

Selecting Advance Speed of Water Temperature Graph

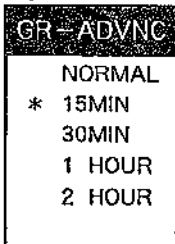

The advance speed of the water temperature can be selected among normal, 15 minutes, 30 minutes, 1 hour and 2 hours, where the time indicates the period to complete a full water temperature graph picture. Refer to the “graph plotting speed” item on page 13.

Activating Water Temperature Alarm

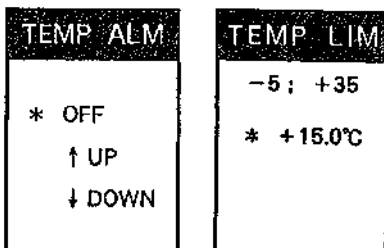

The water temperature alarm can be activated by the **TEMP ALM** menu and its alarm zone set by the **TEMP LIM**. See page 13.

7. MENU SCREEN SETTING

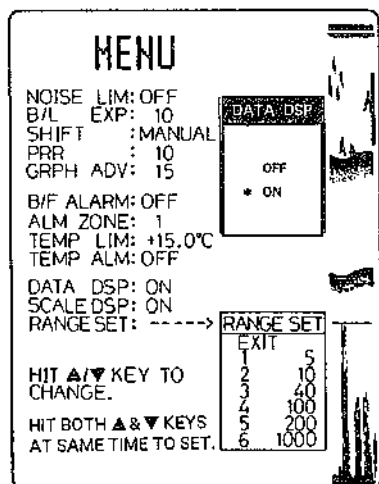

The menu screen as shown at left is displayed when the **MODE** switch is set to the “MENU” position. You may set or select those functions that are not frequently altered in daily use if they have been once preset according to your fishing conditions and preferences.

Operating Procedure

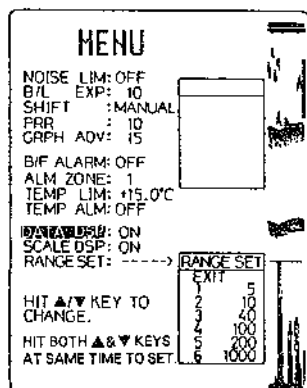

1. Set the **MODE** switch to the “MENU” position.
2. Select the desired item with the **▲** **▼** keys. The selected item is highlighted in white.
3. Press the **▲** and **▼** keys simultaneously. The highlight will shift to the top line of the sub-menu and the parameters are displayed below it.
4. Move the asterisk (*) beside the parameter to be selected, or change the parameter value with the **▲** **▼** keys.
5. Press the **▲** and **▼** keys simultaneously to register the selected parameter. All messages on the sub-menu disappear and the highlight will shift back to the main menu.
6. Turn the **MODE** switch to other position to restore the normal picture.

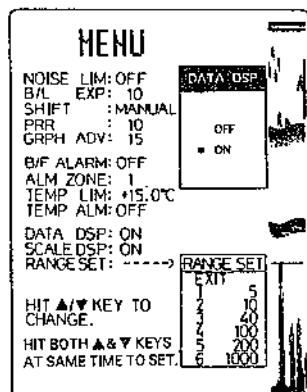

Description of Menu Item

Noise Limiter

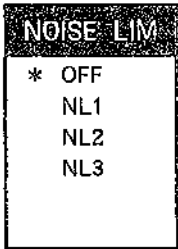

When the interference from other echo sounders operating nearby or other types of electrical interference exist, you may use the noise limiter to eliminate or reduce the interference. The "OFF" position turns off the noise limiter function. Position "NL 3" offers the highest degree of noise rejection. The status of the noise limiter, (OFF), N1, N2 or N3, is indicated on the echo sounder picture.

NOTE: If the noise limiter is left in N3 when no interference exists, weak echoes may be missed or eliminated.

Bottom-lock Range Selection

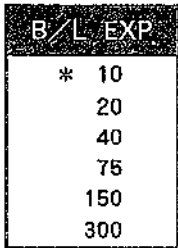

The bottom-lock expansion ranges can be selected among six ranges.

	1	2	3	4	5	6
M	2.5	5	10	20	40	80
FT	10	20	40	80	160	300
FA	1.2	2.5	5	10	20	40
P/B	2.5	5	10	20	40	80

Shift Mode

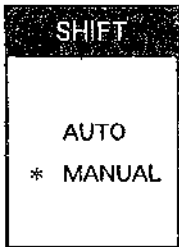

This is the selector of the AUTO or MANUAL shift. The AUTO shift function automatically locates the seabed trace on the lower half of the screen.

The range window jumps up when the seabed trace rises over the center of the screen and jumps down when it reaches the bottom of the screen. The step of jumping is 1/4 of the range in use.

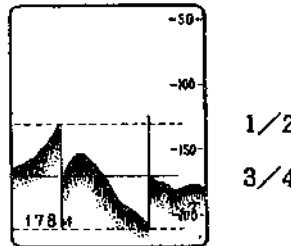

NOTE: The SHIFT \square \square keys are disabled while the AUTO (shift) is in operation.

TX Rate (PRR)

PRR
0-4
5-10 : S
* 10

The transmission repetition rate may be changed in 11 steps (0 ~ 10). Normally the highest rate "10" is used. However when the second reflection echoes of seabed of the last transmission appears between the sea surface and the seabed in shallow water, it is recommended that the rate be reduced.

The "S" denotes the ship's speed dependent mode, where the transmission rate changes automatically according to the ship's speed.

(Advantage of ship's speed dependent mode)

NOTE: For the ship's speed dependent mode, ship's speed information must be fed from the speed/temperature sensor or external navigation equipment.

As you may be aware of, a target is plotted wider horizontally when the ship's speed is low and tends to appear narrow when high because the time which the ship passes over the target differs. Thus you must always bear in mind the ship's speed when judging the size of a target (fish school) on the screen.

The solution for this inconvenience is the "S" (Ship's Speed dependent) mode. Since the transmission rate and as a result the picture advance speed changes in proportion to the ship's speed, the horizontal scale of the picture is not influenced by the change of ship's speed and you can directly compare the sizes of fish schools with the echoes on the screen.

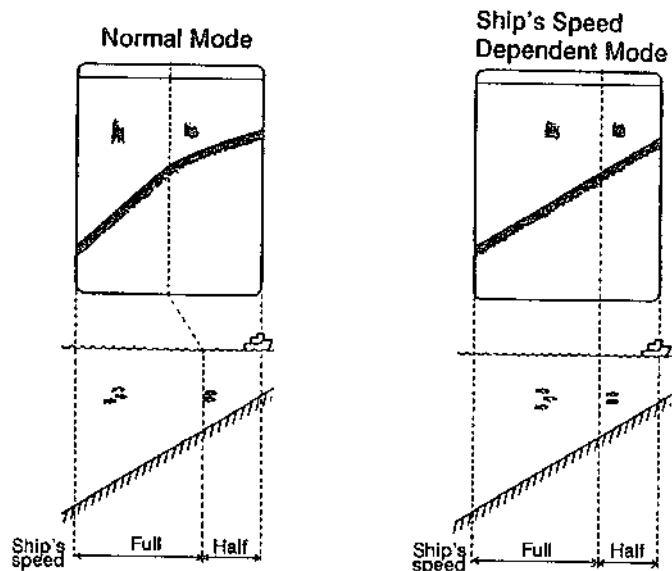

Normal vs. "S" Mode

Graph Plotting Speed

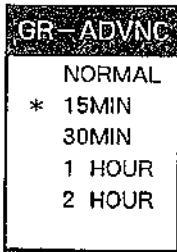

The picture advance speed of the water temperature graph is selected among 15 minutes, 30 minutes, 1 hour and 2 hours. The speed shows the time temperature plotted at a certain time moves from the right edge to the left edge of the screen. In the "NORMAL" setting, the speed becomes the same as the echo sounder picture.

Bottom Alarm And Fish Alarm On/off

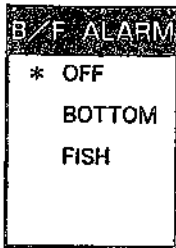

The FCV-561 can generate a fish alarm or bottom alarm. This menu allows selection among OFF, bottom alarm and fish alarm.

NOTE: An echo with a weak echo color can not trigger the alarm: the fish must be plotted in yellow or higher gradation colors in the fish alarm mode and the seabed must be red or reddish brown in the bottom alarm mode.

Alarm Zone

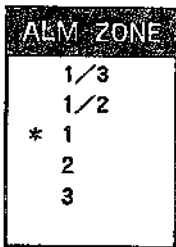

The alarm zone width for the bottom and fish alarms may be set here. The parameters 1/3 to 3 show the width in terms of the division of the depth scale. Two (2), for example, shows that the zone is twice the division of the scale.

Temperature Limit

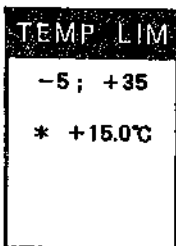

The threshold temperature to trigger the water temperature alarm may be set in 0.1 degree steps between -5°C and +35°C.

Temperature Alarm

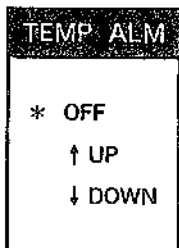

In this item, the water temperature alarm can be turned on/off and the temperature range in which the water temperature alarm is activated may be set.

Up The alarm is activated while the water temperature is above the threshold temperature set at TEMP LIM.

Down The alarm is activated while the water temperature is below the threshold temperature.

Data Display

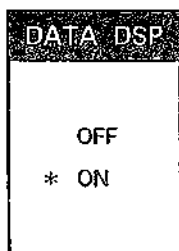

This sub menu allows switching the data display of water temperature, ship's speed and ship's position on and off. This function is disabled on the NAV display which shows all navigation data.

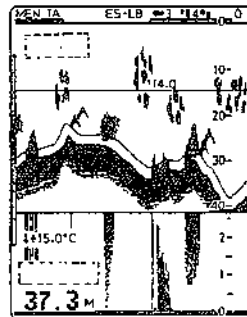
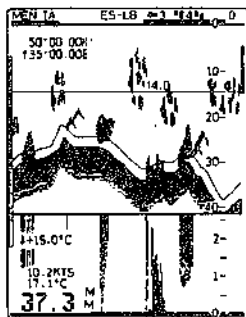

Scale Display

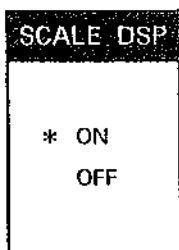

This turns on/off the depth scale.

Range Set

This item permits reprogramming of the factory-set ranges. Any range can be replaced with one picked up from the table below.

	Meters	Feet	Fathoms	P/B		Meters	Feet	Fathoms	P/B
1	5	15	2	3	11	150	500	80	100
2	10	30	5	6	12	200	600	100	120
3	20	60	10	12	13	250	800	120	150
4	30	100	15	20	14	300	1000	150	200
5	40	120	20	25	15	400	1200	200	250
6	50	150	25	30	16	500	1500	250	300
7	60	200	30	40	17	600	2000	300	150
8	80	250	40	50	18	800	2500	400	500
9	100	300	50	60	19	1000	3000	500	600
10	120	400	60	80					

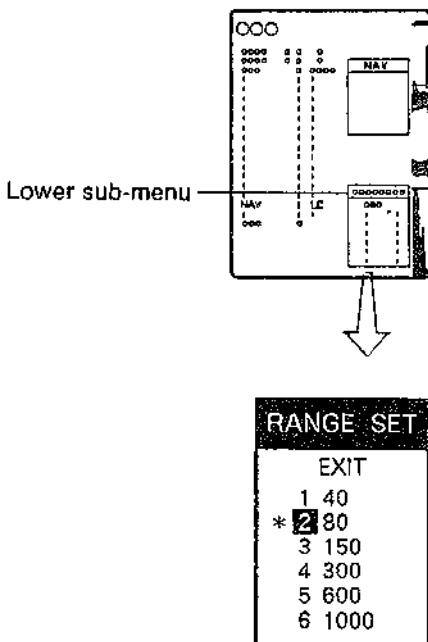

1. Select the "RANGE SET" item and press the keys simultaneously. The top-line of the lower sub-menu is highlighted.
2. Place the asterisk(*) beside the desired range number with the keys and press the keys simultaneously. The range number is highlighted and is now ready to be reprogrammed.
3. Press the or key until the desired range value is displayed.
4. Press the keys simultaneously and the range value set at step #3 is entered.
5. Repeat steps #2 to #4 to reprogram other ranges.
6. To exit from the range set item, move the asterisk(*) beside the "EXIT" message and press the keys simultaneously.

8. INDICATORS

ECHO SOUNDER PICTURE

Normal Mode

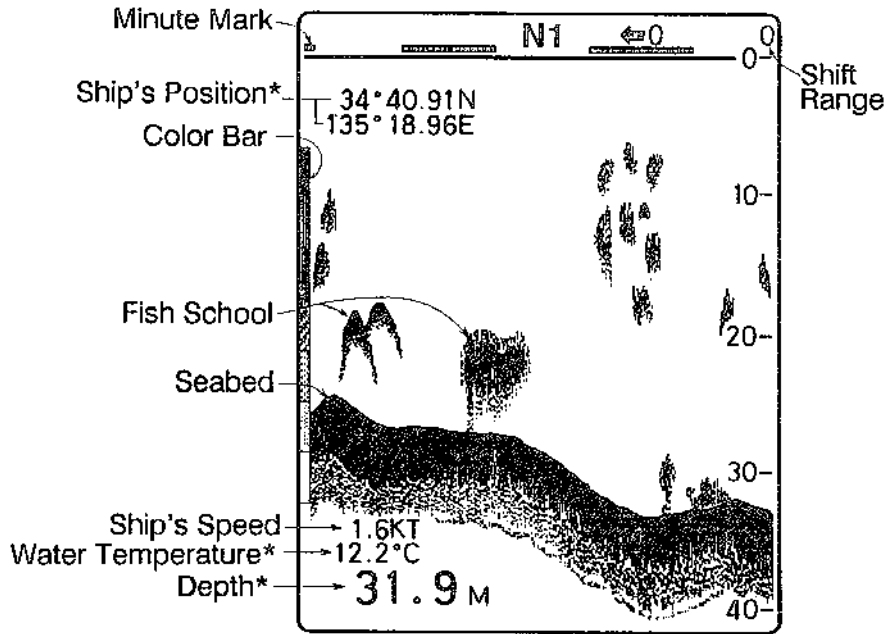

* Position fixing equipment or temperature/speed sensor is required.

Normal + Bottom-Lock (B/L) Expansion Mode

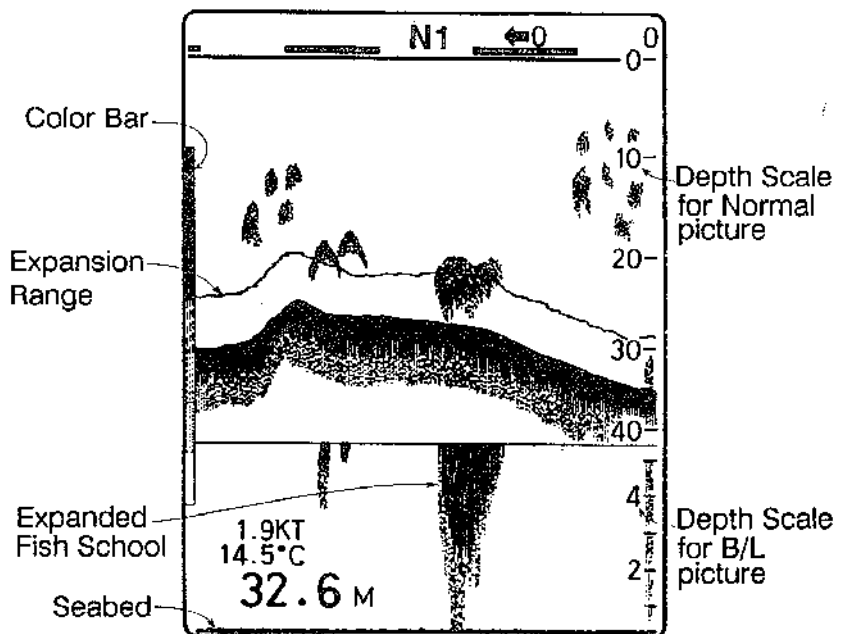

Normal + Zoom Mode

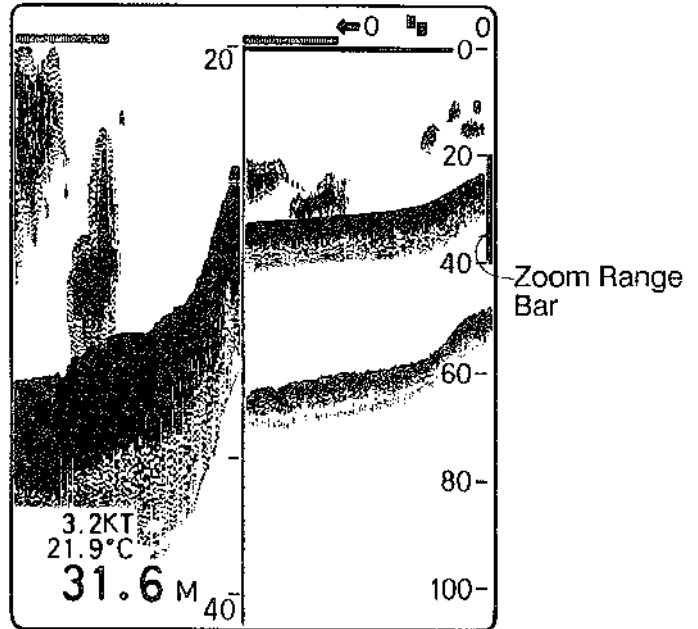

NAVIGATION DATA PICTURE

Navigation Data Mode**

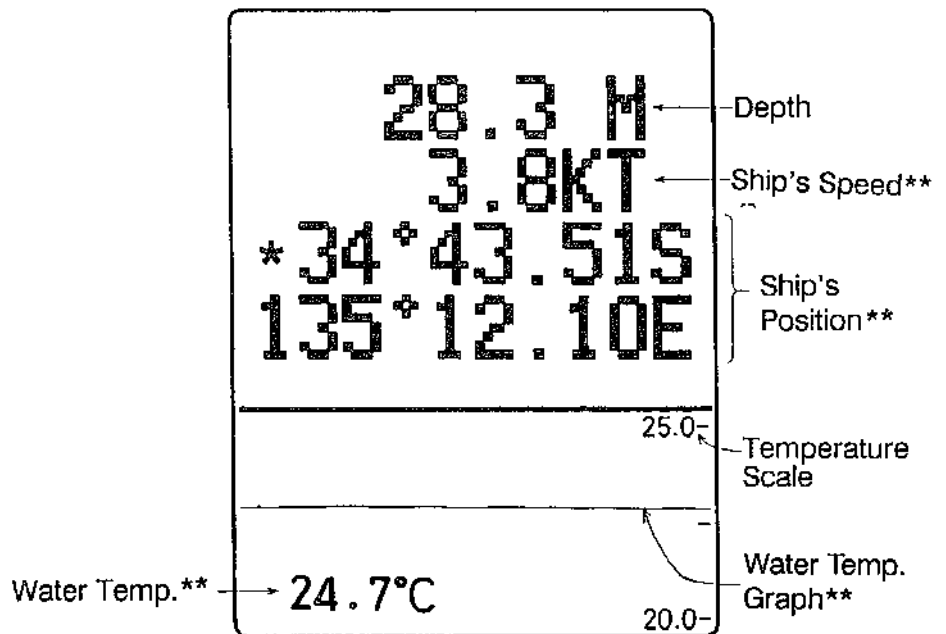

* Ship's position data is unreliable when the asterisk is displayed.

**** Temperature/speed sensor and position fixing equipment required.**

Color Bar: Gives reference of color gradation; reddish brown for the strongest echo to blue for the weakest echo return.

Minute Marker: One complete minute is shown with a 30 sec. horizontal bar and 30 sec. blank space. By observing the number of minute marks on the screen, you can determine the amount of history being displayed on the screen.

Water Depth: This indicator shows the depth from the transducer to the seabed. The unit is capable of reading depths beginning from 1m below the transducer. This minimum depth is necessary to prevent locking onto the surface turbulence rather than the bottom. In order to obtain depth readout, the bottom must be displayed on the screen. Correct depth readout is displayed even when the picture advance rate is set to "0".

9. IF SOMETHING SHOULD GO WRONG WITH YOUR UNIT

If the unit does not operate properly, perform the following Operation Check to determine whether your unit is really defective. If there is a problem, proceed to the System Diagnosis section (p.20), and report the results at service call.

OPERATION CHECK

No Echo Presentation, But Scale Shows.

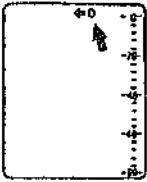

- * Is the ADVANCE (picture advance speed) set to "0" (stop)?
Normal setting is "4"

No Zero Line



- * Is the range shift reading "0"?
If the range is shifted several meters or more, the zero line is not displayed.

Low Sensitivity



- Are the GAIN controls properly set?

No Water Depth Readout/Bottom Lock Inoperative



- * Is the seabed echo present within the normal picture range?
- * Is the seabed return strong enough; i.e., red or reddish brown?

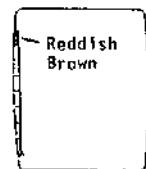

Picture Distorted



- * Is a magnetic field generator (heavy duty transformer, rectifier, etc.) nearby?

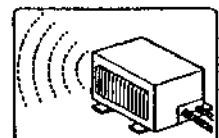

SYSTEM DIAGNOSIS (SELF-CHECK)

Your unit is provided with the self-check facilities which may be initiated by the following operation.

- 1) Turn off the unit.
- 2) Turn on the unit while pressing the  key.

In a few seconds, the self-check page is displayed on the screen as follows.

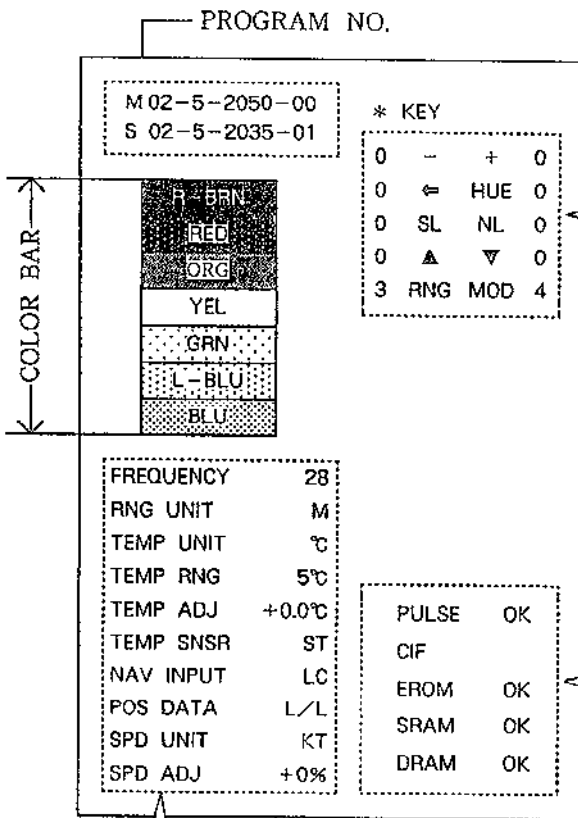
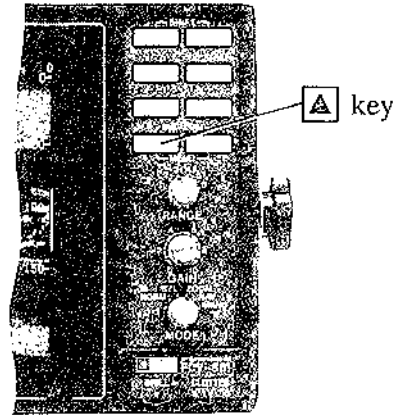

PANEL SWITCH CHECK

While "*" is displayed beside the KEY, the function of each key can be checked. Operate each key while observing the screen. ("ON" → 1, "OFF" → 0)

FUNCTION/DEVICE CHECK

Pressing the  key moves the asterisk(*) to the item "PULSE" and starts checking each device in the order displayed on the screen. In the DRAM check, the entire screen is painted in reddish brown and white four times and finally check results are given. If everything is normal, "OK" is indicated. If something is wrong, "OK" is not displayed.

Indication of the system menu setting.
(See page 27.)

NOTE: CIF can be checked in the factory only using a special connection cable. In the field, no indication is normal.

- 3) To terminate the system diagnosis, turn off the unit.

10. INSTALLATION

DISPLAY UNIT

Install the display unit at such place.

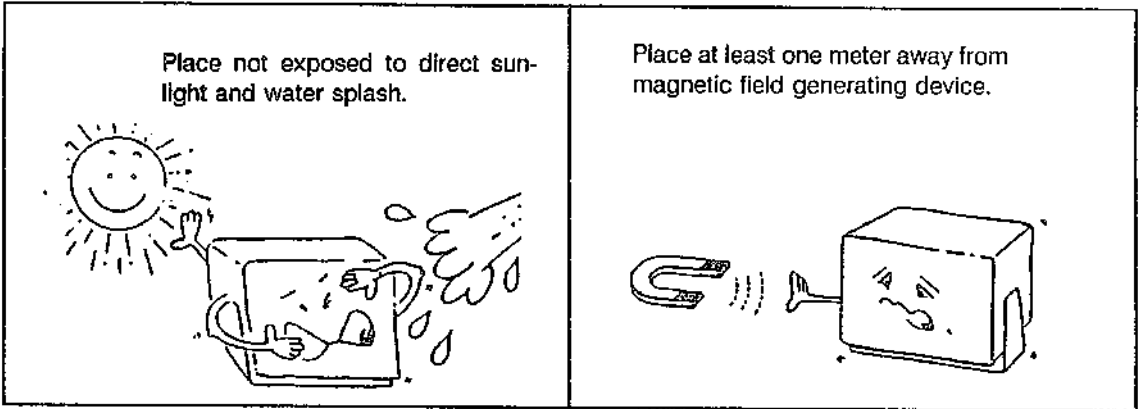

Allow service/ventilation space indicated below.

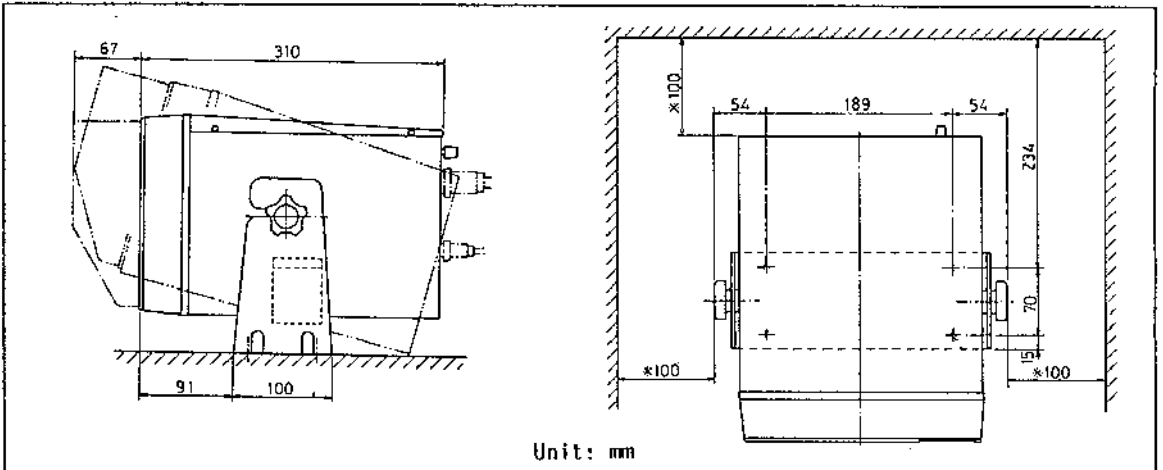

Use proper power supply with sufficient capacity (50W or more) and low ripple factor.

Ground the unit to the ship's hull with copper strap.

Mounting Procedure

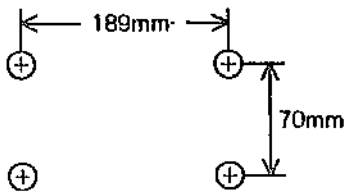

1. Drill four 7mm dia. holes for the bracket.
2. Fix the bracket with M5 bolt or woodscrews.
3. Install the display unit on the bracket.

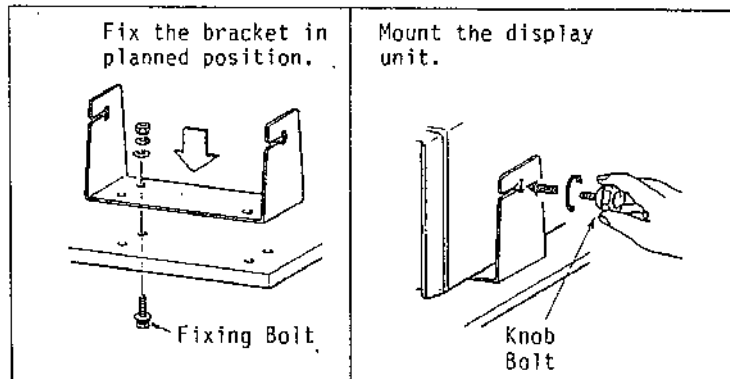

OVERHEAD MOUNTING ALLOWED, BUT NO BULKHEAD MOUNTING.

TRANSDUCER

The performance of the color video sounder depends greatly upon the transducer position. A place least affected by AIR BUBBLES should be selected since turbulence blocks sounding capability. Also select a place least influenced by ENGINE NOISE. The following figures show typical transducer installation site, examples of transducer mounting.

It is known that bubbles are at a minimum at the place where the first bow wave falls and the next wave rises at general cruising speed. In small slow-speed boats, the position shown in the illustration is usually a good place.

For high speed boats, select a place where the transducer is always in contact with the water.

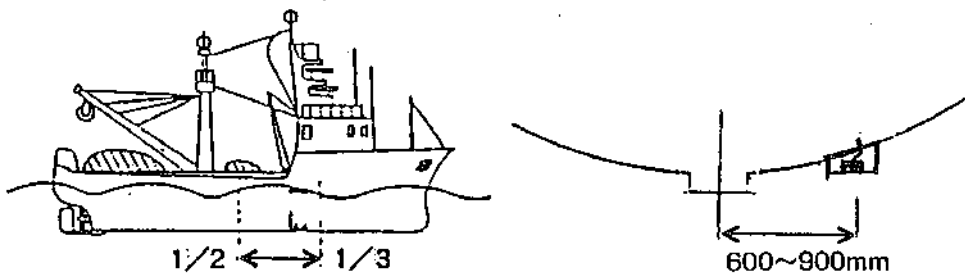

NOTE: *The face of the transducer must be parallel with the sea bottom in the normal cruising trim of the boat.*

FCV-561 CABLING DIAGRAM

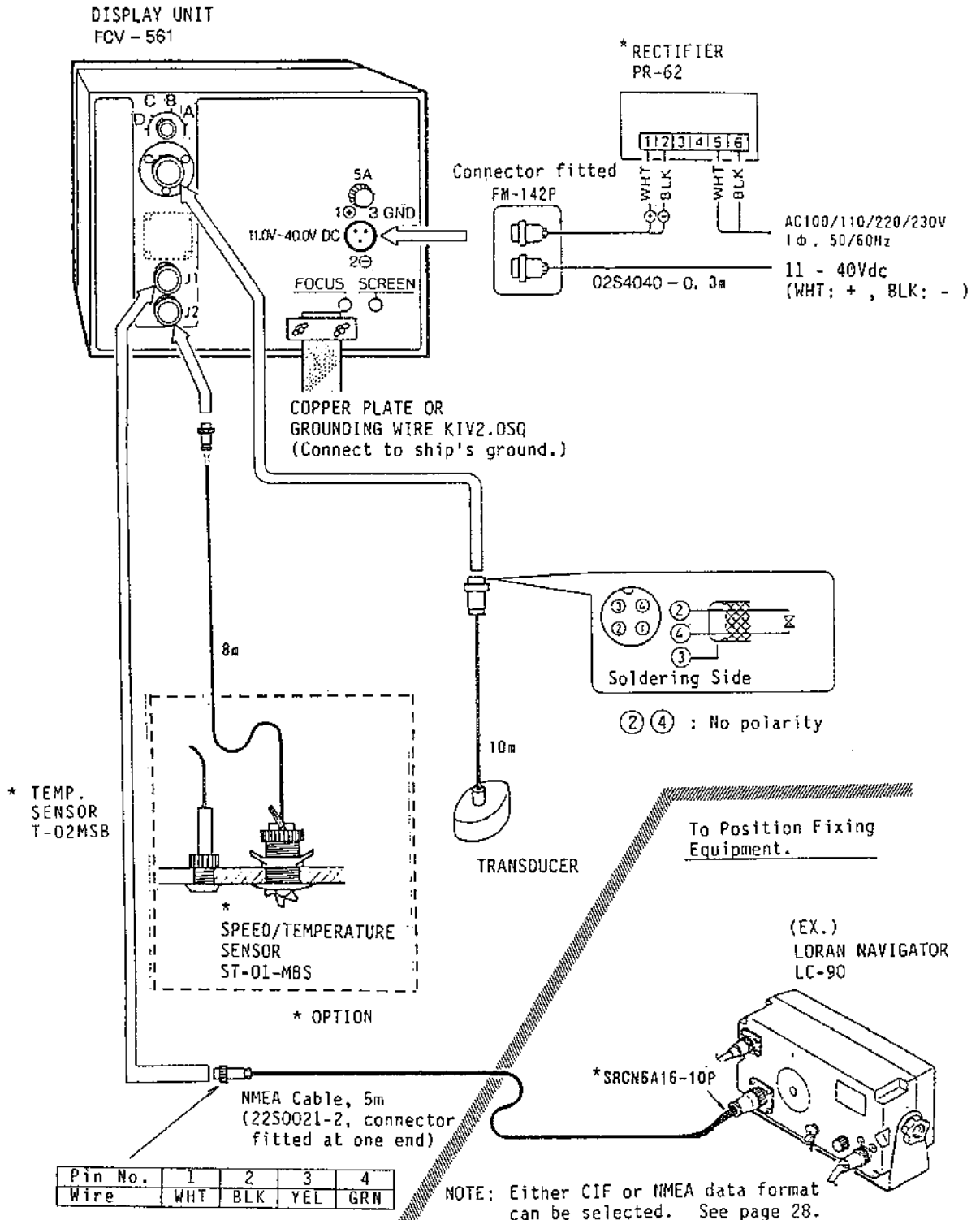

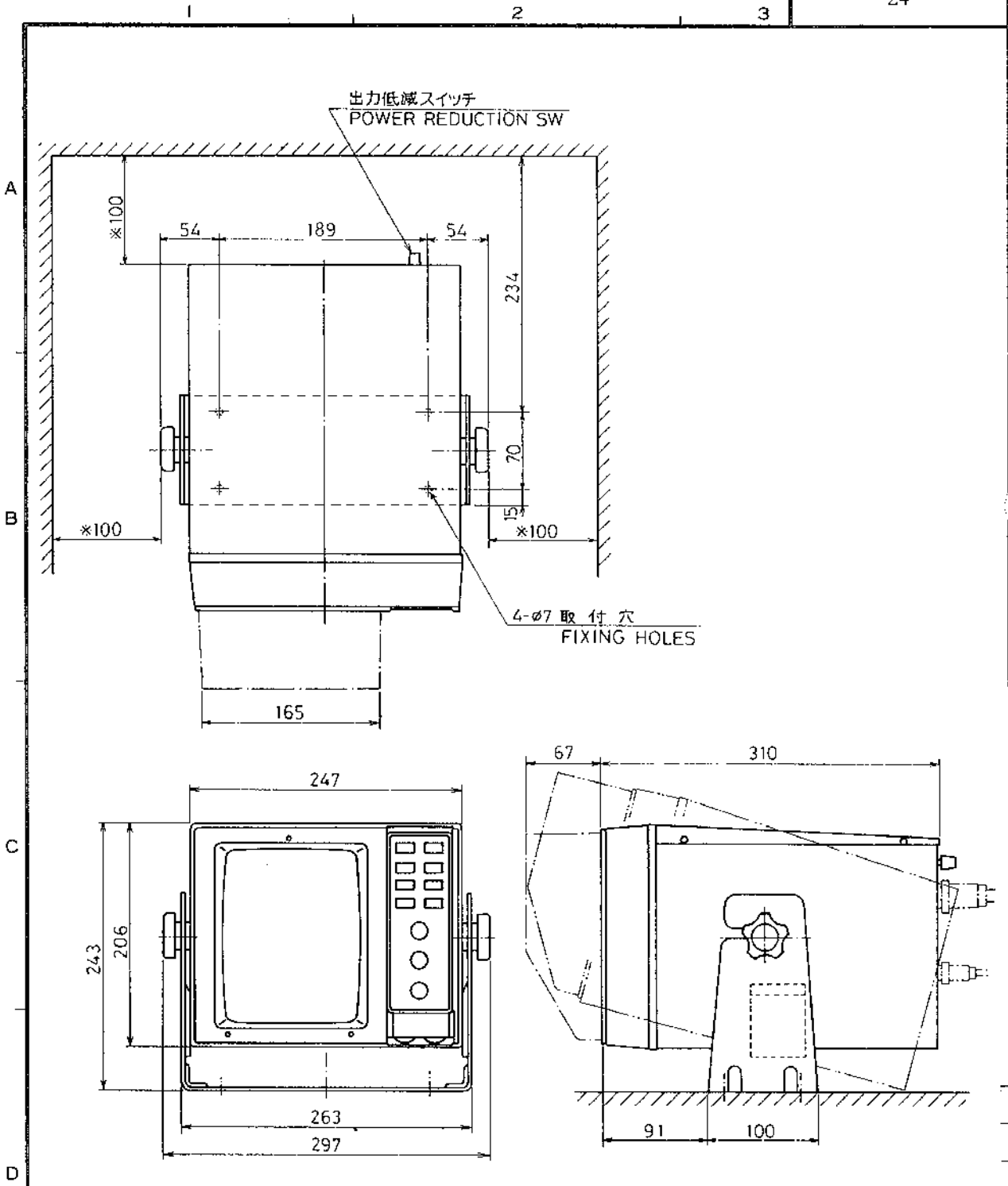

※保守用スペース
SERVICE SPACE

承認 APPROVED	品番 ITEM	品名 NAME	材質 MATERIAL	数量 Q'TY	図番 DWG.NO.	摘要 REMARKS
OCT. 9. 89 T. MIYASHI		三角法 THIRD ANGLE PROJECTION				名称 TITLE FCV-561 指示器 DISPLAY UNIT
接図 CHECKED	OCT. 9. 89 M. UYAMA	尺 度 SCALE		1 / 5		
製 図 DRAWN	OCT. 9. 89 T. MIYASHI	重 量 WEIGHT		8 kg	図 番 DWG.NO.	C2324-G01-A

HOOKING UP SHIP'S POSITION DATA FROM POSITION FIXING EQUIPMENT

FURUNO LC-90 Loran Navigator

To interface the LC-90 with the video sounder, the NMEA cable CP02-02320 and the connector SRCN6A16-10P (Code No. 000-508-663) are optionally required.

This sounder can accept either FURUNO CIF or NMEA 0183 format data, and may be connected to either Port-1 (pin #1 and #2) or Port-2 (pin #5 and #6) of the LC-90. If you wish to connect an autopilot (NMEA 0180) to the LC-90, however, you should connect this sounder to Port-1, leaving Port-2 for the autopilot. Note that only Port-2 can output the data of NMEA 0180 format.

According to the output port (Port-1 or Port-2) you selected, solder the yellow and green leads to the connector (pin #1/2 or pin #5/6) and connect the both units.

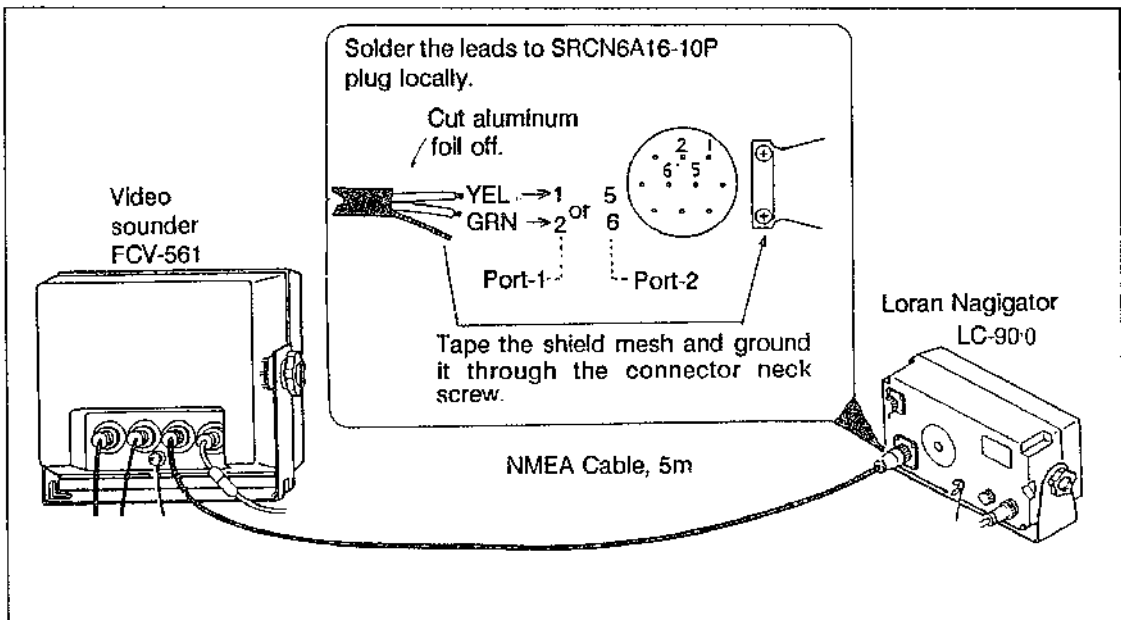

Selection of the data format

After having connected the sounder to the loran navigator LC-90, select the output format on the LC-90 side following the procedures below.

- 1) Press # and 3 keys in order to select Function 3, and the formats assigned to Port-1 and Port-2 will be presented as shown right.
- 2) Press ∇ key until the cursor moves down to the P-1 line.
- 3) Press CLR key.
- 4) Press +/- key several times until "183" or "CIF" is displayed at the right of the port number where your unit is connected.
- 5) Press ENT key.

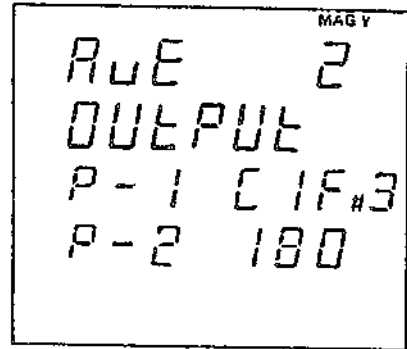

FURUNO FSN-50 Satellite Navigator

To interface with the FSN-50, the NMEA cable and the NH-11P connector assembly are optionally required. The FCV-561 color video sounder can accept only the data transferred in NMEA 0183 format from the satellite navigator, therefore should be connected to #1/2 of the J402 on the CPU BOARD as shown below.

Selection of the data format is performed by the jumper wire between #10 and #11 on the connector

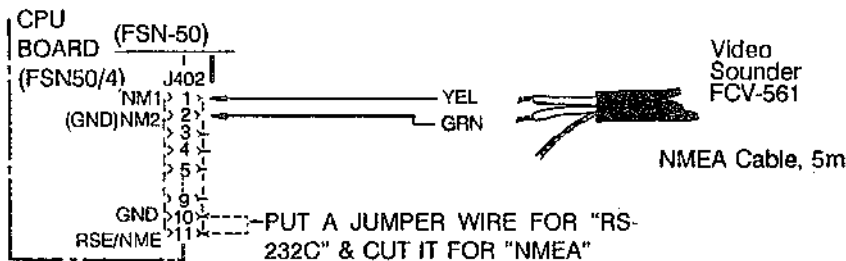

Other Make Position Fixing Equipment With NMEA 0183 Data Format

As the NMEA cable is supplied optionally, procure a plug for the accompany position fixing equipment locally. The wiring is similar to the above diagram: connect the yellow and green leads to the SIGNAL and RETURN lines respectively. And ground the shield of the cable with the CHASSIS of the equipment.

Sentences which can be input/output to/from this color sounder are listed below.

Input (Data accepted by FCV-561)	Output (Data output to interfaced set)
<ul style="list-style-type: none"> (a) \$-GLL (Lat./long.) (b) \$-GTD (LOP) (c) \$-VTG (Ship's ground speed) (d) \$-MTW (Water temperature) (e) \$-RMA Loran-C (Lat./Long.) (f) \$-RMC GPS (Lat./Long.) 	<ul style="list-style-type: none"> (a) \$SDDBT (Depth)

11. AFTER INSTALLATION CHECK

It is necessary to change/confirm the system menu settings according to user's preference, combined navigation equipment, etc.

Operation Procedure

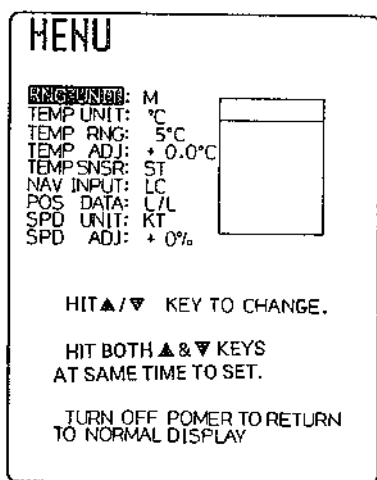

1. Turn on the unit while pressing the **ADVANCE** key. The system menu will be displayed.
2. Check that settings of all menu items confirm to combined navigation equipment and user's preference. If not, change the settings. Refer to page 10 for key strokes required to change settings.

Description of System Menu Item

ITEMS	SUB-MENU	CONTENTS
RNG UNIT	* M FT FA P/B	Depth unit selection
TEMP UNIT	* °C °F	Temperature unit selection
TEMP RNG	* 5°C 10°C	Water temperature range selection
TEMP ADJ	-5: +5 * +0.0°C	Water temperature compensation It can be set in 0.1° steps upto ±5°C.
TEMP SNSR	* ST NAV	Water temperature data selection Select "ST" when the unit is connected to temperature/speed sensor and "NAV" when the data comes from the position fixing equipment.

NAV INPUT	LA *LC GPS DR DECCA OTHERS	<p>This is the selector of the navigation equipment from which the ship's position data is entered.</p> <p>LA Loran-A navigator LC Loran-C navigator DECCA . Decca navigator GPS GPS navigator DR DR navigation (Sat-nav connected with gyro and log) Others . . Omega or other navigation equipment.</p> <p><i>NOTE: 1. For sat-nav combined with loran-A or C in Furuno CIF data format, select LA or LC.</i></p> <p><i>2. For the GPS-300, select the GPS irrespective of combined equipment.</i></p>
POS DATA	*L/L TD	<p>This item permits display of the ship's position in either latitude/longitude (L/L) or time difference (T/D) when the set is connected to loran navigator.</p> <p><i>NOTE: When the Furuno CIF data format is selected with DIP switch on MIN board, the TD can be displayed only when LA or LC is set at item NAV INPUT. In case of NMEA #183 data format, TD data from any equipment is accepted.</i></p>
SPD UNIT	*KT MPH	<p>Ship's speed unit selection; "KT" for knot and "MPH" for meters per hour.</p>
SPD ADJ	-30%: +30% * +1%	<p>Ship's speed compensation; $\pm 30\%$ in 1% steps.</p>

NOTE: The system menu settings can be confirmed on the self-check screen. See page 20.

Changing Data Format

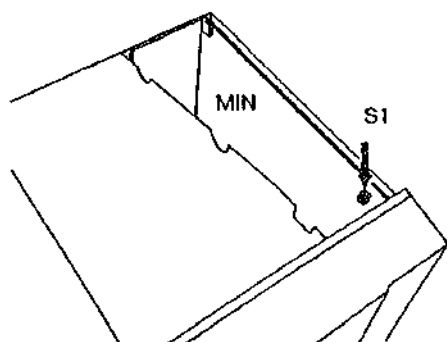

The data format of the FCV-561 is set to the FURUNO CIF format at the factory. To set it to the NMEA 0183 format change the setting of DIP switch S1 on the MIN board (02P6097).

S1	Item	ON	OFF
#1	Data Format	CIF	NMEA
#2	Not used		
#3	Not used		

12 SPECIFICATIONS

1. Display

8" diagonal CRT.

2. Echo Color

8 colors depending echo intensity. Five, six or seven color presentation is also available. The background color is selectable from blue, dark blue and black.

3. Basic Display Range

No. Unit	1	2	3	4	5	6
M	10	20	40	80	150	300
FT	30	60	120	250	500	1000
FA	5	10	20	40	80	160
P/B	6	12	25	50	100	200

1) Display start depth can be shifted in 1m (FT, FA P/B) steps.

2) Operator can reprogram the basic display range; the shallowest range available is 5m and the deepest one 1000m.

4. Bottom Lock
Expansion Range

	1	2	3	4	5	6
M	2.5	5	10	20	40	80
FT	10	20	40	80	160	300
FA	1.2	2.5	5	10	20	40
P/B	2.5	5	10	20	40	80

5. Automatic bottom
Tracking

Display start depth is automatically shifted to display the bottom on the lower half of the screen.

6. Presentation Mode

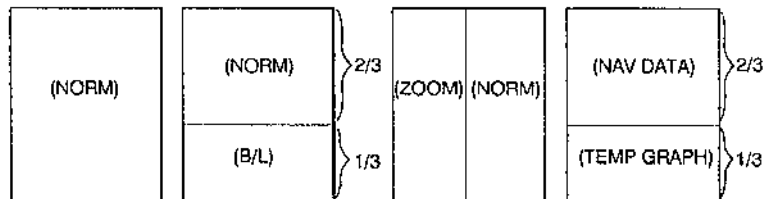

NOTE: Connection with temperature/speed sensor or position fixing equipment is required for nav. data display.

7. Picture Advance Speed

	0	1	2	3	4
Lines/TX	Freeze	1/6	1/4	1/2	1/1

Ship's speed dependent advance is available

8. Memory Backup

All key settings are stored in the memory while the power is off.

9. Transmit Frequency

28, 50, 68, 88 or 200kHz

10. Output Power

500Wrms (with power reduction switch)

11. Pulselength/Repetition Rate

End of Range(M)	PRR	Pulselength(ms)		Repetition Rate(Pulses/Min)			
		0~4	5~10,s	Min,(0)	Max,(10)	S(2KTS)	S(20KTS)
0 ~ 20		0.4	0.2	91	610	61	610
21 ~ 40		0.6	0.25				
41 ~ 60		0.8	0.4	80	305	31	305
61 ~ 80		1.0	0.5				
81 ~ 100		1.2	0.6	71	204	20	204
101 ~ 160		1.4	0.8				
161 ~ 200		1.6	1.0				
201 ~ 250		1.8	1.2	54	108	11	108
251 ~ 300		2.0	1.4				
301 ~ 400		2.2	1.6				
401 ~ 500		2.4	1.8	43	60	6	60
501 ~ 600		2.6	2.0				
601 ~ 640		3.0	2.4				
641 ~ 800		3.0	2.4	*1	*2	*3	*2
801 ~ 1280		3.6	3.0				
1281 ~		5.0	3.6	*1	*2	*3	*2

NOTE: 1. Repetition rate can be changed in 11 steps from min. (0) to max (10).

2. Pulselength is interlocked with display end range and pulse repetition rate.

3. *1: $45000 \div (\text{End range} + 420)$

*2: $45000 \div (\text{End range})$

*3: $4500 \div (\text{End range})$

12. Noise Limiter

Rejects unwanted signals by comparing last and present echoes in strength.

13. Alarm

Bottom or fish alarm. In addition, water temperature alarm is available when optional speed/temperature sensor is connected.

14. Input/Output Data
(CIF or NMEA
Format)

Input: Ship's position (L/L or LOP)
Ship's speed (KT or MPH)
Water temperature (°C or °F)

Output: Depth

15. Environmental
Condition

Temperature: 0 ~ 50°C
Humidity: 95% or less
(Splash proof structure)

16. Power Supply

11-40VDC, less than 45W
Rectifier PR-62 (option) is required for operation on
100/110/220/230VAC

500W Transducer & Hull Bottom/Sideboard Installation Materials

Fre- quency	Transducer (Code No.)	Hull Bottom Installation			Sideboard Installation	
		Shlp's Hull	Tank (Code No.)	Thru-hull Pipe (Code No.)	Type	Pipe length (Code No.)
28kHz	28F - 8 (000 - 015 - 003)	Steel	T - 604 (000 - 015 - 512)	TFB - 5000 (000 - 015 - 206)	T - 514	2.3m (000 - 015 - 416)
		FRP	T - 604 - F (000 - 015 - 513)	TRB - 1000 (000 - 015 - 215)		2.7m (000 - 015 - 564)
		Wood	T - 604 - W (000 - 015 - 514)	TFB - 1000 (000 - 015 - 201)		
50kHz	50B - 6/50B - 6B (000 - 015 - 042)/ (000 - 015 - 043)	Steel	T - 605 (000 - 015 - 515)	TFB - 5000 (000 - 015 - 206)	T - 27	2.3m (000 - 015 - 313)
		FRP	T - 605 - F (000 - 015 - 516)	TFB - 1000 (000 - 015 - 215)		2.7m (000 - 015 - 557)
		Wood	T - 605 - W (000 - 015 - 517)	TFB - 1000 (000 - 015 - 201)		
	50B - 62M (000 - 152 - 510)	—	—	—	—	—
68kHz	68F - 8H (000 - 015 - 067)	Steel	T - 621 (000 - 015 - 966)	TFB - 5000 (000 - 015 - 206)	T - 621 - S	2.3m (000 - 015 - 973)
		FRP	T - 621 - F (000 - 015 - 967)	TRB - 1000 (000 - 015 - 215)		2.7m (000 - 015 - 974)
		Wood	T - 621 - W (000 - 015 - 969)	TFB - 1000 (000 - 015 - 201)		
88kHz	88B - 8 (000 - 015 - 024)	Steel	T - 606 (000 - 015 - 518)	TFB - 5000 (000 - 015 - 206)	T - 221	2.3m (000 - 015 - 366)
		FRP	T - 606 - F (000 - 015 - 519)	TRB - 1000 (000 - 015 - 215)		2.7m (000 - 015 - 560)
		Wood	T - 606 - W (000 - 015 - 520)	TFB - 1000 (000 - 015 - 201)		
	88B - 82M (000 - 152 - 530)	—	—	—	—	—
200kHz	200B - 5S (000 - 015 - 029)	Steel	T - 605	TFB - 5000 (000 - 015 - 206)	T - 27	2.3m (000 - 015 - 313)
		FRP	T - 605 - F	TRB - 1000 (000 - 015 - 215)		2.7m (000 - 015 - 557)
		Wood	T - 605 - W (000 - 015 - 517)	TFB - 1000 (000 - 015 - 201)		

300W Transducer and Hull Bottom/Sideboard Installation Materials

Fre- quency	Transducer (Code No.)	Hull Bottom Installation			Sideboard Installation	
		Shlp's Hull	Tank (Code No.)	Thru-hull Pipe (Code No.)	Type	Pipe length (Code No.)
50kHz	50B - 5NR' (000 - 015 - 014)	—	—	—	T - 230	1.8m (000 - 015 - 371)
200kHz	200B - 5NR' (000 - 015 - 028)	—	—	—	T - 231	1.8m (000 - 015 - 372)

1kW Transducer and Hull Bottom/Sideboard Installation Materials

Frequency	Transducer (Code No.)	Hull Bottom Installation			Sideboard Installation	
		Ship's Hull	Tank (Code No.)	Thru-hull Pipe (Code No.)	Type	Pipe length (Code No.)
50kHz	50B - 9B (000 - 015 - 065)	Steel	T - 603 (000 - 015 - 509)	TFB - 5000 (000 - 015 - 206)	T - 63	2.3m (000 - 015 - 326)
		FRP	T - 603 - F (000 - 015 - 510)	TRB - 1000 (000 - 015 - 215)		2.7m (000 - 015 - 562)
		Wood	T - 603 - W (000 - 015 - 511)	TFB - 1000 (000 - 015 - 201)		
	50B - 92M (3AP - 870 - 801)	—	—	—	—	—
200kHz	200B - 8/ 200B - 8B (000 - 015 - 030) (000 - 015 - 032)	Steel	T - 608 (000 - 015 - 525)	TFB - 5000 (000 - 015 - 206)	T - 31	2.3m (000 - 015 - 317)
		FRP	T - 608 - F (000 - 015 - 526)	TRB - 1000 (000 - 015 - 215)		2.7m (000 - 015 - 559)
		Wood	T - 608 - W (000 - 015 - 527)	TFB - 1000 (000 - 015 - 201)		
	200B - 82M (3AP - 870 - 803)	—	—	—	—	—

Note : Modification of the FCV-561 is required to use the 300W or 1kW transducers.

Complete Set

No.	Name	Type	Q'ty	Code No.
1	Display Unit	CV - 561	1	
2	Transducer		1	
3	Installation Materials	CP02 - 04200	1set	000 - 024 - 797
4	Accessories	FP02 - 02700	1set	000 - 024 - 952
5	Spare Parts	SP02 - 02300	1set	000 - 024 - 732

Accessories

No.	Name	Type	Q'ty	Code No.
1	Bracket Assembly	FP02 - 01410	1	001 - 273 - 880
2	Filter Assembly	FP02 - 02710	1	002 - 134 - 000
3	Knob Bolt Assembly	FP02 - 00250	2	001 - 336 - 840
4	Hood	02 - 43 - 1301 - 2	1	204 - 313 - 012
5	Cover	02 - 074 - 1431 - 0	1	000 - 801 - 095

Spare Parts

No.	Name	Type	Q'ty	Code No.
1	Fuse	FGBO – A 5A AC125V	3	000 – 549 – 064

Installation Materials

No.	Name	Type	Q'ty	Code No.
1	Power Cable	02S4040 – 0.3m	1	000 – 118 – 326
2	Connector	NCS – 254 – P	1	000 – 506 – 505
3	Vinyl Sheath Wire	KIV 2.0 SQ BLACK 2m	1	000 – 554 – 516

Option





No.	Name	Type	Code No.
1	Transducer Tank		
2	Thru-hull Pipe		
3	Temperature/Speed Sensor	ST – 01MSB	000 – 014 – 329
4	Temperature Sensor	T – 02MSB	000 – 040 – 044
5	NMEA Cable	CP02 – 02320	001 – 358 – 810
6	NMEA Cable(Shielded)	CP02 – 04410	002 – 140 – 020
7	Filter *1	FP02 – 02210	001 – 366 – 510
8	Rectifier	PR – 62, 100VAC PR – 62, 110VAC PR – 62, 220VAC	000 – 013 – 484 000 – 013 – 485 000 – 013 – 486

*1. Electro-magnetic shield filter





APPENDIX

1. Starting FCV-561 with Factory Settings or User's Standard Settings

All switch settings are stored in the memory while the power is off and the FCV-561 starts in the last used settings when switched on in the next time. In addition to this normal starting, the FCV-561 can be started with either the factory or user's standard settings as described below.

Operation	Description
Turn on the set while pressing the SIG LEV key simultaneously.	The FCV-561 starts with the factory settings. Refer to page AP-4 for the contents of the factory settings.
Turn on the set while pressing the  key.	<p>The FCV-561 starts with the user's standard settings.</p> <p><u>How to store user's standard setting</u></p> <ol style="list-style-type: none">1) Set all front panel keys and menu screen items to the desired value.2) Press the  and  keys simultaneously for approximately 3 seconds until beep is heard. <p><i>NOTE: 1) The   keys should be pressed while the E/S mode screen is displayed.</i></p> <p><i>2) Only one set of the settings can be stored; when new settings are stored, old ones are erased.</i></p> <p>This feature will be useful;</p> <ol style="list-style-type: none">1. To store the settings used in a particular fishing ground and recall them later.2. To quickly restore the user's most often used settings.

2. List of Special Key Operation

Key Operation	Function
ADVANCE + Power "ON"	Displaying system menu screen. See page 27.
 + Power "ON"	Displaying self-check screen. See page 20.
SIG LEV + Power "ON"	Starting FCV-561 with factory settings.
 + Power "ON"	Starting FCV-561 with user's standard settings.
 +  (for 3 seconds)	Storing user's standard settings.

3. Combination of Background color and Echo Colors

Combination of the background and echo colors can be changed in seven steps as shown below with the HUE key.

On-screen indication	Background Color	Echo Colors							Total Color
		R-BRN	RED	ORG	YEL	GRN	L-BLU	BLU	
HUE 1	Black	○	○	○	○	○	○	○	8
HUE 2	Black	○	○	○	○	○	○	←	7
HUE 3	Black	→	○	○	○	○	○	←	6
HUE 4	D-Blue	○	○	○	○	○	○	○	8
HUE 5	D-Blue	○	○	○	○	○	○	←	7
HUE 6	Blue	→	○	○	○	○	○	←	6
HUE 7	L-Blue	→	○	○	○	○	○	←	5

NOTE: The arrow shows that the color is the same as that of the right or left hand column; that is, the echoes displayed in blue in the HUE 1, for example, are displayed in light blue in the HUE 2.

4. Changing Output Power to 300W or 1kW

The output power of the FCV-561 is 500Wrms at standard but can be changed to 300W or 1kW in order to use the already installed transducer.

Procedure

- 1) Change the jumper block position on the MIN board (02P6097) as shown below.

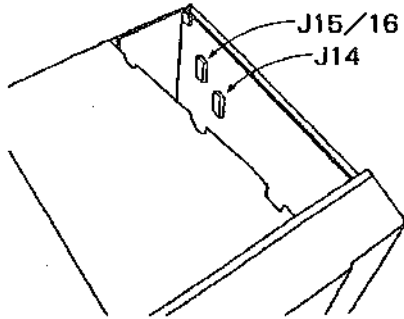

Output	Jumper Block		
	P12	P15	P16
300W	A	A	A
500W	B	B	B
1kW	C	C*	C*

* "B" for 200kHz

- 2) Check that the transducer is of the correct type.

Output	Frequency (kHz)				
	28	50	68	88	200
300W	—	50B-5NR	—	—	200B-5NR
500W	28F-8	50B-6/6B (50B-6G)	68F-8H	88B-8 (88B-82M)	200B-5S
1kW	—	50B-9B 50F-8G	—	—	200B-8/8B 200B-82M

5. List of Factory Settings

	Item	Settings
Keyboard Setting on Front Panel	ADVANCE	3
	HUE	1
	SIG LEV	0
	ALARM	OFF
	SHIFT	0
System Menu Setting	RNG UNIT	M
	TEMP UNIT	°C
	TEMP RNG	5°C
	TEMP ADJ	+0.0°C
	TEMP SNSR	ST
	NAV INPUT	LC
	POS DATA	L/L
	SPD UNIT	KT
SPD ADJ	+0%	
Menu Setting	NOISE LIM	OFF
	B/L EXP	2
	SHIFT	MANUAL
	PRR	10
	GRAPH ADV	15 MIN
	B/F ALARM	OFF
	ALM ZONE	1
	TEMP LIM	+15°C
	TEMP ALR	OFF
	DATA DSP	ON
	SCALE DSP	ON
	RANGE SET	1 10
		2 20
	3 40	
	4 80	
	5 150	
	6 300	

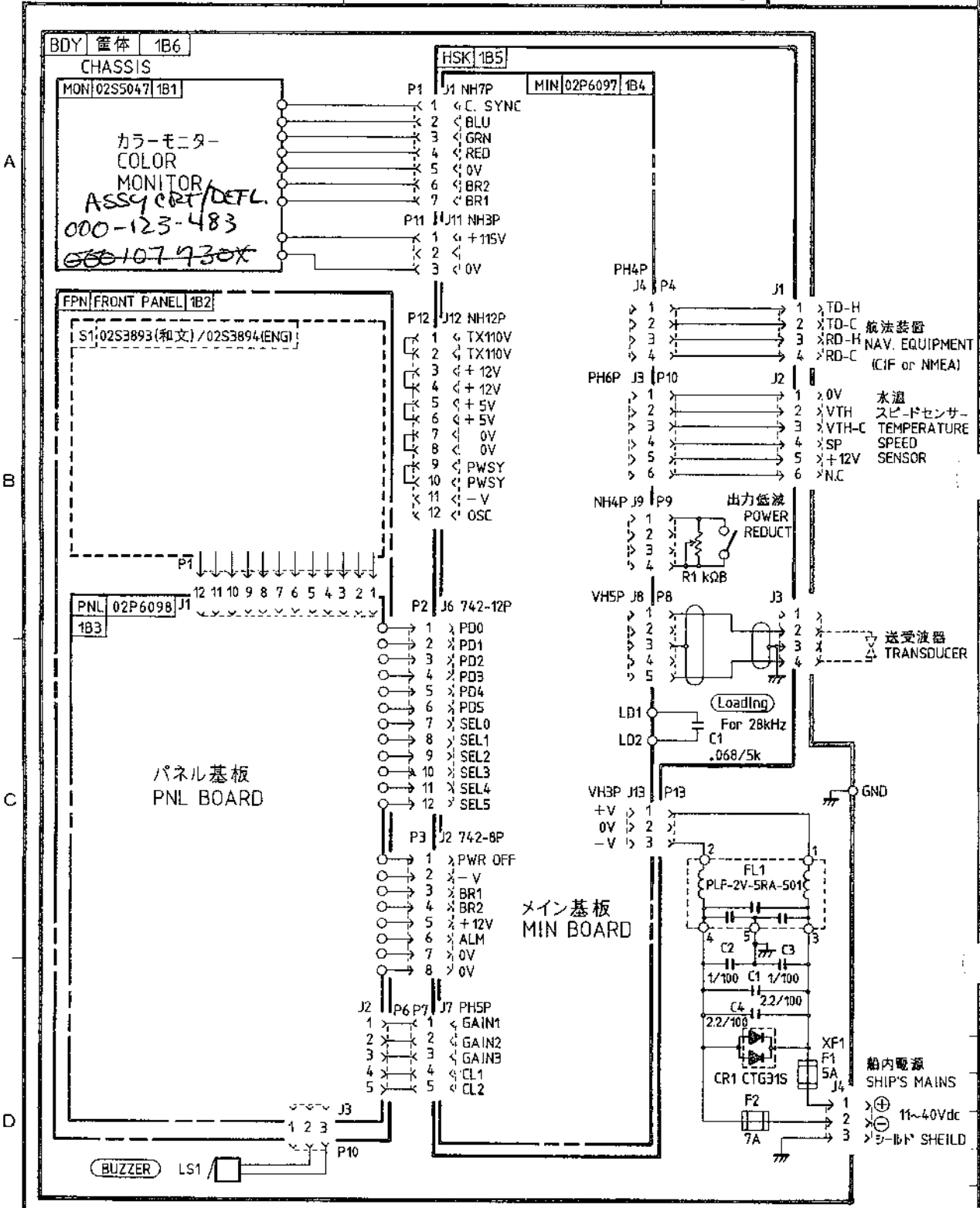

品番 ITEM	品名 NAME	材質 MATERIAL	数量 Q'TY	図番 DWG. NO.	摘要 REMARKS
------------	------------	----------------	------------	----------------	---------------

承認 APPROVED	007.12.89 TAKAKAWA	三角法 THIRD ANGLE PROJECTION		名称 TITLE FCV-561 指示部回路図 DISPLAY UNIT	
検図 CHECKED	007.12.89 M. LISUDA	尺度 SCALE	/		
製図 DRAWN	007.4.89 T. MIYOSHI	重量 WEIGHT	kg	図番 DWG. NO.	C2324-K01-A

A

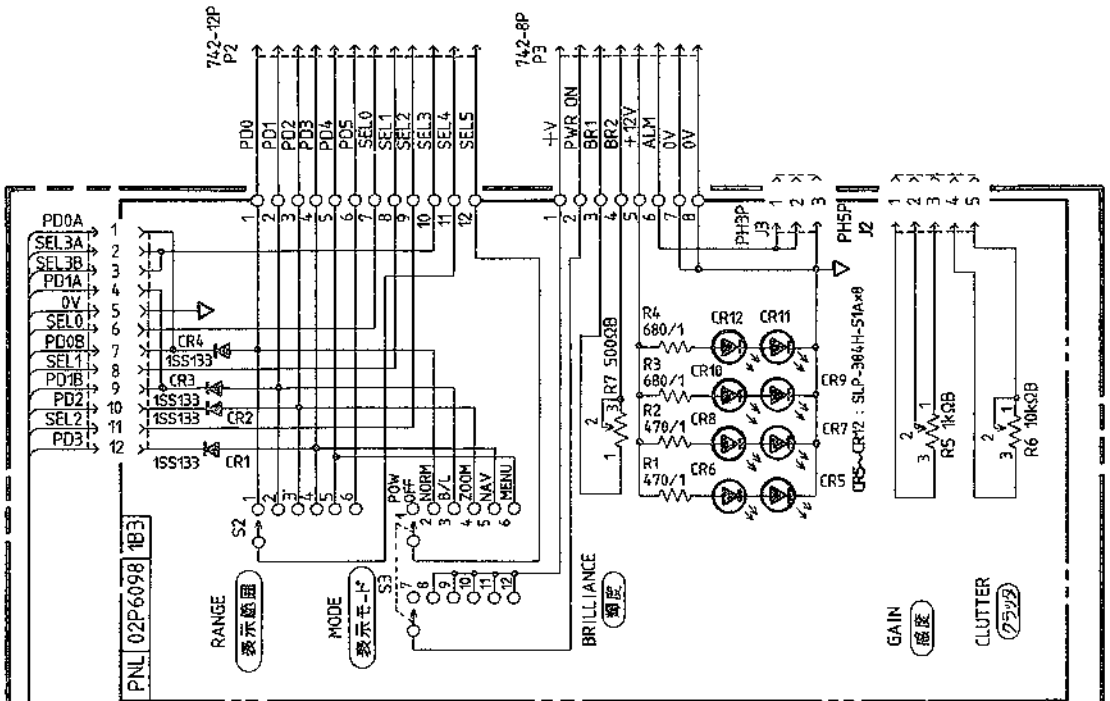

C

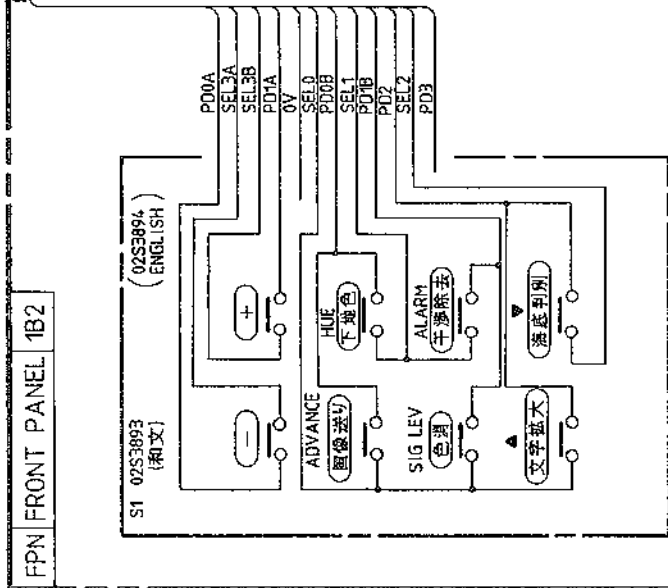

D

承認 APPROVED	品番 ITEM	品名 NAME	材質 MATERIAL	数量 Q'TY	図番 DWG.NO.	摘要 REMARKS
OCT.12.89 T. NAKANO		三角法 THIRD ANGLE PROJECTION				名称 TITLE FCV-561 パネル基板 PNL BOARD
検 CHECKED	OCT.12.89 M. USUDA	R 度 SCALE				
製 DRAWN	OCT.4.89 T. MIYOSHI	重 量 WEIGHT	kg		図 番 DWG.NO.	C2324-K02-A

超小型電源
SHF-P S MAINS
11-40Vdc

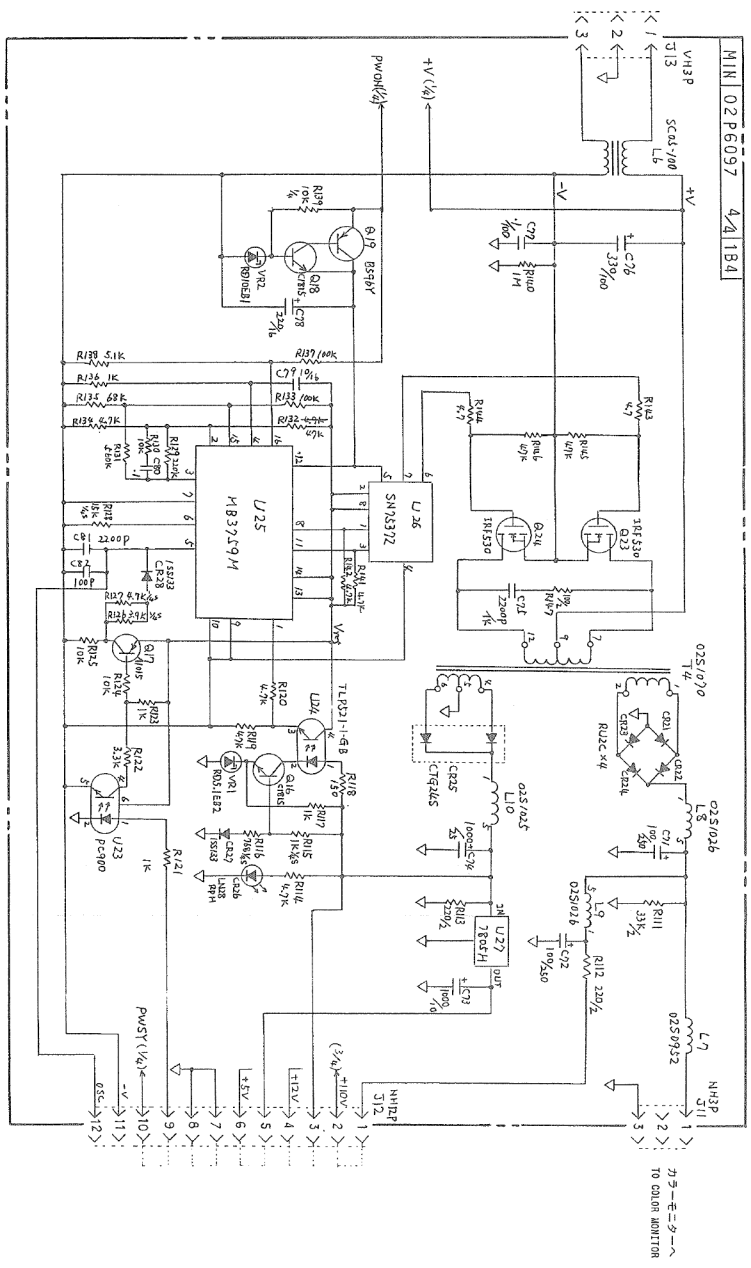

MINI 02P6097 4/41B4

FW-561

承認	設計	DATE	名
APPROVED	DESIGNED	2.2.87	TITLE
検図	チェック	1/15/87	02P6097
CHECKED	1/15/87		MIN 基板 (1/4)
製図	DRAWN	1/17/87	
DRAWN	1/17/87		MIN BOARD
	FIG. NO.	C2324-K06-A	

FURUNO ELECTRIC CO., LTD.



 **FURUNO ELECTRIC CO., LTD.**

No. 9-52, ASHIHARA-CHO,
NISHINOMIYA-CITY, JAPAN

TELEPHONE : 0798-65-2111
CABLE : FURUNO NISHINOMIYA
TELEX : 5644-325/326 FURUNO J
TELEFAX : 0798-65-4200 (G I /G II)

YOUR LOCAL AGENT/DEALER

--